



Gaylord's Tech Department is constantly making the best better, here are some common hardware renderings which might be slightly different upon arrival. For ANY installation questions please email us info@gaylordslids.com

please visit us on the web for any additional Info @ WWW.GAYLORDSLIDS.COM

Gaylord's would like to thank you for your custom lid purchase. We greatly appreciate your business and strive to produce top quality custom bed covers for your custom classic!

53-73 FORD F-100 Stepside Drill-In Kit

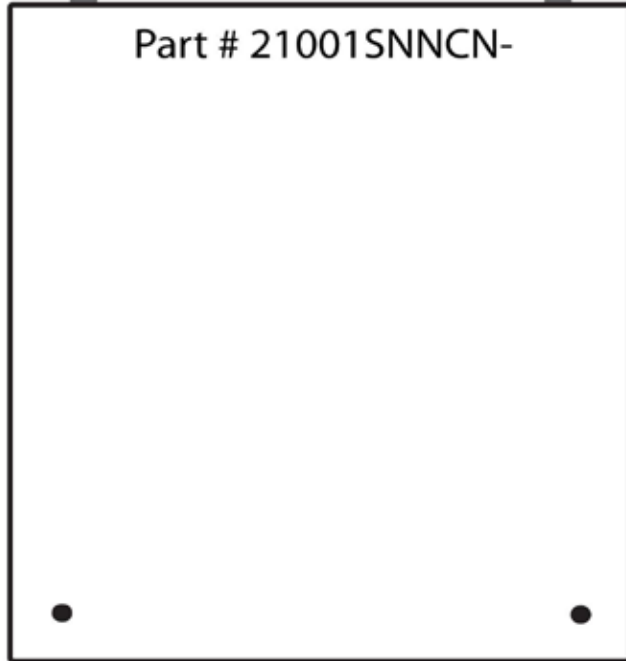

Part # 21001SNNCN-

(8) Round Head 1" Screws (front tabs)



(4) Self Tappers (strikers)



(4) Allen Heads (shock mount)

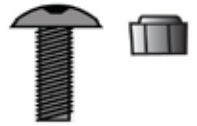

(2) Type Two Drill In Front Bracket-Female

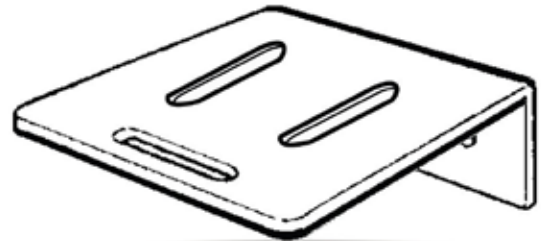

Dual Locks and Keys (2)



(2) 20" 90 lbs Shock

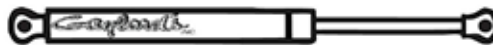

(2) Striker Brackets



(2) Angled Shock Mounts

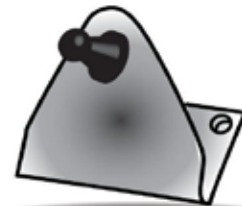

PAGE 1

WARNING: If you are not familiar with the use of hand tools or are not accustomed to working on motor vehicles, have a dealer or accessory shop install the Kustom Lid. Carefully read all the instructions prior to attempting to fit the Lid. Before fitting the Lid, park the vehicle on level ground in a well lit area and apply the emergency brake. After installation, check that the Lid works correctly and securely locks shut. Periodically check all fasteners for tightness. Retighten only the loose fasteners. When using power or hand tools, always wear the correct protective clothing recommended by the tool manufacturer.



Installation Instructions

53-73 FORD F100

Visit our Site for any Additional Info @ WWW.GAYLORDSLIDS.COM



**** BEFORE INSTALLATION PLEASE TAPE UP THE BED****



Approx. Bracket Location Shown
-Remove it Prior to Marking Bed-

Marking The Location of The Front Tabs

- Set the lid on the truck, with the tailgate closed square it up on the bed to your preferences.
- Using a china marker, draw the location of the front tabs onto the truck bed. We suggest trace the shape so when removed you know exactly where the tabs were.
- Scoot the lid back, and carefully drill in the tab. The provided plastic spacers can be inserted after the tabs have been drilled, just in case you need to scoot the lid back.

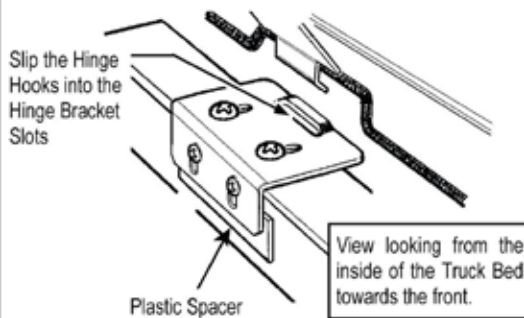

Hooking The Lid

- With the help of two buddies, one on each side at the front, lift the lid up from the rear and hook it into the female slots.
- Greasing up the tabs and cycling it up and down a few times insures proper operation of the tabs.
- If the lid is too tight at the rear, insert the plastic spacers provided in the kit. Be conscious the same number on each side. The lid should be about 3/8" from the tailgate.

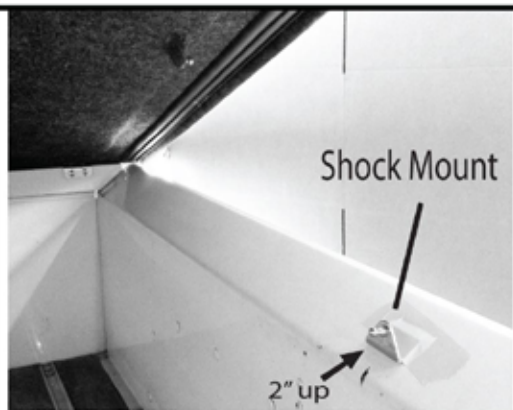

Shock Mounts

- Measuring back 13" from the shock mount on the lid, mount the shock mount to the slant of the bed rail 2" from the bend.
- Mark the location of the two holes on the shock mount.
- Use a 3/16ths drill bit to drill the two holes through the bed rail.
- Install the button head bolts provided in the kit.
- You may now hook the shocks up, the thicker end of the shock will be the side mounting to the lid.

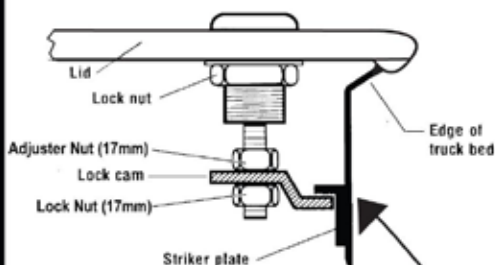

Striker will most likely be higher than this

Drilling Striker Bracket Into Bedside

- Once the lid is installed properly you must now install the strikers. Assemble the lock as shown and use it to determine the best place to mount the striker. Normally its at the top of the bed side. The one in the illustration to the left is slightly lower than the new style strikers.
- Your finished! Enjoy your beautiful new Gaylord's lid and please periodically check the hardware to ensure everything stays tight.